

The world's most trusted OSAs

AQ6370 Series
Optical Spectrum Analyzer



No longer confined to telecommunications, the emergence of photonics in industrial manufacturing, biological studies, healthcare, lighting, imaging and sensing for safety, security and environmental pollution control is today driving the demand for wider ranging wavelengths and higher precision measurement.

Our long experience working with customers in the optical Test & Measurement Industry has enabled us to design the world's most reliable and versatile Optical Spectrum Analyzers. In fact they feature specific technical characteristics that make them the most efficient and effective instruments for measuring devices and systems used in the various applications of photonics.

Yokogawa's AQ6370 OSA Series can satisfy the specific test and measurement needs of R&D and manufacturing centers belonging to any Industry.

The AQ6370 OSA Series delivers:

Reliability – The most trusted OSAs in the world thanks to their unmatched measurement accuracy, robustness and proven quality.

Performance – Best in class, state of the art and high-precision instruments that keep pace with the ever changing and fast evolving optical technology.

Expertise – For more than 30 years our R&D and Product Specialist teams have been listening to the needs of OSA users to continuously provide them with innovative and effective solutions for their measuring challenges.

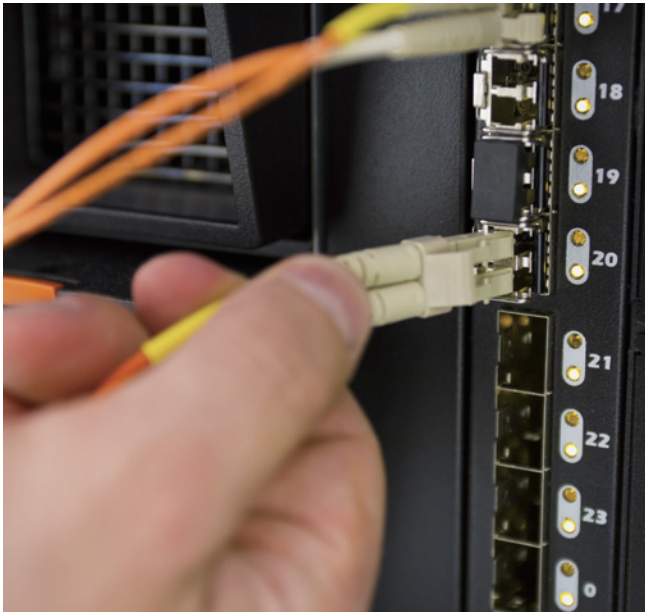

30+ years of experience

In 2002 Yokogawa became a leading supplier of optical spectrum analyzers following the acquisition of Ando Electric. Today, with more than 30 years of experience in optical testing, Yokogawa can offer a full range of OSAs, each one specifically designed to accurately and quickly measure the performance of photonic devices and systems used in diverse applications.

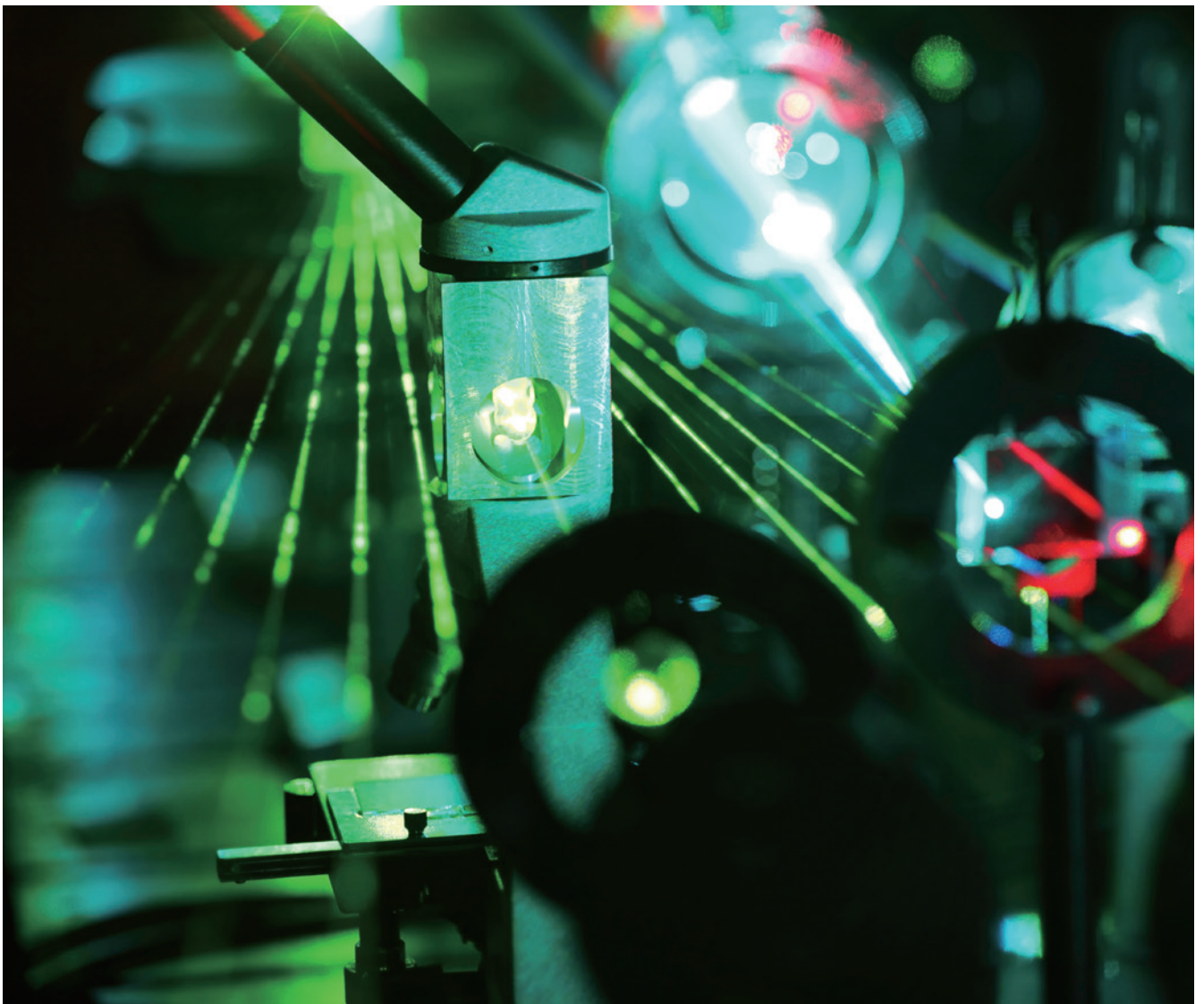

Leading solutions for R&D and industrial applications

The Yokogawa AQ6370 Series are benchtop Optical Spectrum Analyzers (OSA) which offer test & measurement advanced functionalities to a wide range of R&D and industrial manufacturing applications.

AQ6370D (600 to 1700 nm)

The ideal model for the characterization and test of optical components and systems used in the telecommunications Industry.

AQ6373B (350 to 1200 nm)

Designed to outperform in optical measurements taken in VIS (visible) and NIR (near infrared) regions.

AQ6375B (1200 to 2400 nm)

Required when your application requires detection and precise characterization of signals emitted in the exNIR (extended Near InfraRed) and SWIR (Short-Wavelength InfraRed) regions.

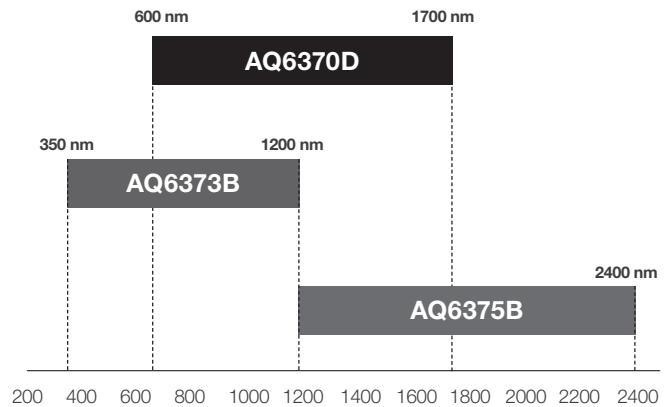

5 World class optical performance and unique characteristics

The highest resolution (up to 20 pm) & highest close-in dynamic range (up to 78 dB)

The advanced monochromator enables the detection of spectral signals which are in close proximity to be distinguished and accurately measured.

The highest sensitivity (down to -90 dBm)

Low-power optical signals can be measured accurately and quickly, without any need to use averaging over many measurements. Moreover, with the *High Dynamic Mode* enabled, the instrument will maximize its dynamic range performance by eliminating the influence of stray-light, a disturbing factor for the photodetector caused by strong input signal which increases the noise floor.

The widest measurement power range (up to 110 dB)

The high quality photodetector and the smart design of the gain circuitry enable the AQ6370 Series to have an incredibly wide measurement power range. The OSA can analyze very strong signals without being damaged and very weak signals as well, with a great accuracy.

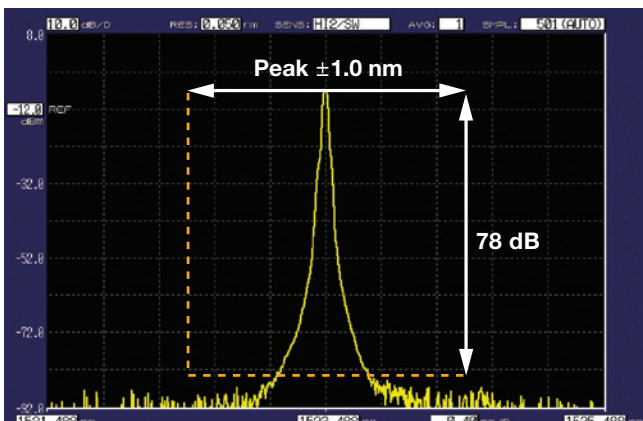

AQ6370D, Peak ± 1.0 nm, resolution setting 0.05 nm, High dynamic mode: ON, High performance model, typical

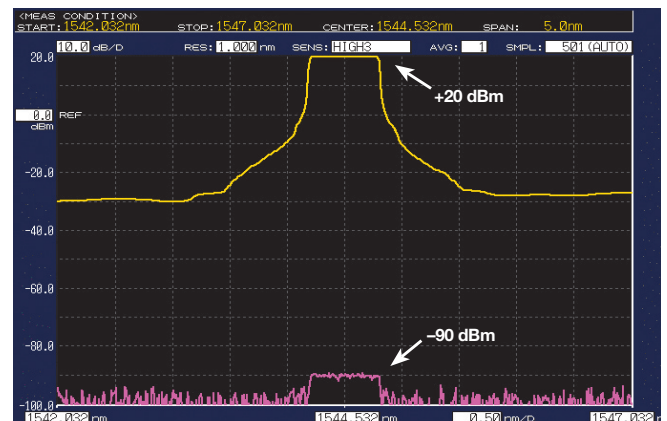

AQ6370D, Sensitivity setting: HIGH3 High dynamic mode: OFF, typical



The built-in calibration source

Ambient temperature change, vibrations and shock affect the measurement accuracy of high precision products like optical spectrum analyzers. We want our OSAs to be able to deliver always the precise measurements they were designed for, therefore our instruments are equipped with a light source for calibration.

Calibration process is fully automatic and takes only 2 minutes to complete. It includes:

- The Optical Alignment function, which automatically aligns the optical path in the monochromator to assure the level accuracy;
- The Wavelength Calibration function, which automatically calibrates the spectrum analyzer with the reference source to ensure the wavelength accuracy.

The free space optical input

The optical input structure designed for the AQ6370 Series is the most effective to guarantee high coupling efficiency, measurements repeatability and no maintenance.

The free space optical input is, in fact:

- Dual purpose:* accepts both SM and MM (up to 800 μm core diameter) fibers without the high insertion loss due to the mismatch between MM and SM fibers
- Versatile:* accepts both /PC and /APC connectors
- Worry-free:* no internal fiber can be scratched by inaccurate coupling of fibers
- Maintenance-free:* no internal fiber can get dirty

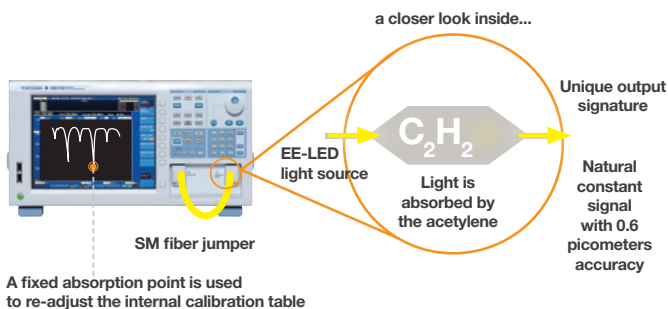

The built-in reference source for wavelength calibration, available for AQ6370D and AQ6375B

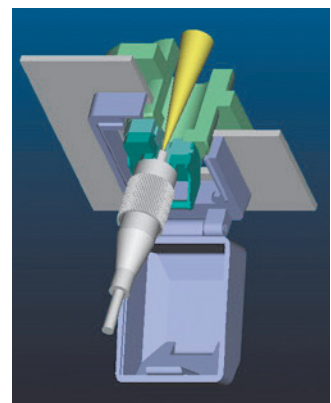

Optical input structure (note. AQ6373B uses a fixed connector)

7 The greatest flexibility to set parameters

The AQ6370 Series has been designed to guarantee testing flexibility: plenty of parameters' settings help the user to configure the instrument to obtain the maximum measurement performance according to the specific requirement of each test session.

OSA performance are derived by the following 4 main parameters: Power Sensitivity, Spectral Resolution, Measurement Speed and Close-In Dynamic Range.

AQ6370 Series users can tune their instrument in order to make it the best performer for the specific application they are about to test. By choosing the right combination of values of the mentioned parameters, the user can have an OSA extremely fast or extremely sensitive or with extremely high resolution.

The user of any AQ6370 Series OSA can set the measurement conditions by choosing among:

- 7 level sensitivity values
- Up to 10^{*1} wavelength resolution values
- ANY wavelength span^{*2}, including 0 nm span
- ANY number of averaging times from 1 to 999
- ANY number of sampling points from 101 to 50001^{*3}

**1: 6 res. values selectable in AQ6375B, 7 res. values selectable in AQ6370D, 10 res. values selectable in AQ6373B*

**2: within the wavelength range covered by each model*

**3: minimum sampling interval = 1 pm for AQ6370D and AQ6373B, 2 pm for AQ6375B*



Highly efficient functions to save time and increase productivity

Reducing the design and manufacturing costs is a key target for vendors of optical devices.

Test & Measurement instruments for optical devices' evaluation are therefore expected to lower the finished product cost by shortening its inspection time after manufacturing and by increasing productivity of R&D and Production personnel.

Fast measurement at any sensitivity value

With a state-of-the-art monochromator, fast gain circuits and advanced noise reduction techniques, the AQ6370 series achieves an incredibly fast scanning speed even when measuring low power signals.

Up to 16* specific data analysis functions

The AQ6370 series OSAs have built-in analysis functions to characterize WDM systems, optical fiber amplifiers, different types of light sources and filters. The automatic calculation of the major parameters of the device under test will contribute to its fast characterisation.

Building automated test systems

Any model of the AQ6370 Series, thanks to the built-in Macro Programming Function, can perform automatic measurements and control external equipment through its remote interfaces. GP-IB, RS-232 and Ethernet ports are available to have the instrument remotely controlled by a PC and to transfer standard SCPI-compatible or proprietary AQ6317-compatible commands. Also LabVIEW® drivers are available.

**Each model of the AQ6370 Series has a different list of built-in analysis functions. Discover them into the product-specific sections further on this brochure.*

The AQ6370 Viewer

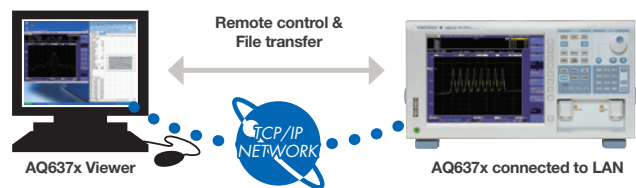

Real-time remote control

With the AQ6370 Viewer, a software package which replicates on your PC the instrument's screen, you can:

- remotely control and operate with the instrument;
- display, analyze and transfer the data acquired by the instrument on your remote PC.

The AQ6370 Viewer is appreciated especially by:

- Production Managers, who can command the instrument and collect its measurement results from their office without physically going to the actual production line.
- Service Engineers, who can help their customers or colleagues by setting the instrument in the proper way, tuning it on the device/system they want to test.

9 Various features for a comfortable test environment

Mouse and keyboard operation

More than 30 years of feedback from users has enabled intuitive and easy-to-use front panel operation. Mouse functionality provides ease of use for navigation and the keyboard helps to enter numbers and file names.



Point the item to modify



Modify settings using the keys on the screen.

Trace zooming

- Change display conditions, such as center wavelength and span, by clicking and dragging the mouse.
- Enlarge your area of interest instantly and move it at will.
- No need for another measurement to modify the display conditions.

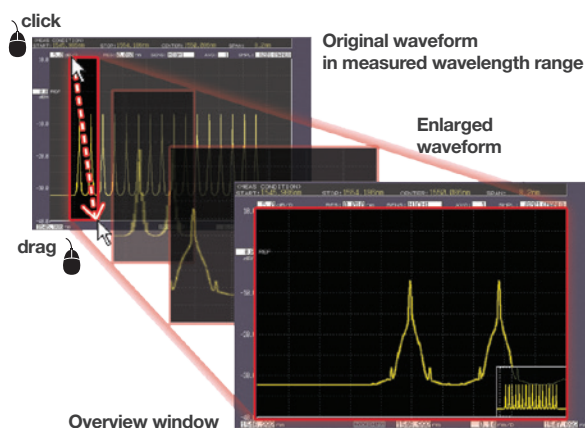

Trace calculation and analysis

Seven individual traces

- Simultaneous multi-trace display;
- Calculation between traces (subtraction between traces);
- Max / Min Hold function.



USB ports

Four USB ports in total available on front and back facilitate the use of external devices such as a mouse, keyboard, external hard drives and memory sticks.

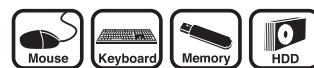

Thumbnail file preview

The thumbnail allows an easy and fast route to find a particular file out of many files in internal and external storage.

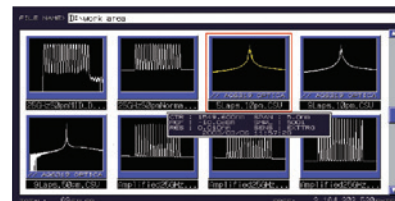

All-at once trace filing

A time-saving feature which allows to save all seven traces in one file at once. Files are saved in CSV format and can be easily manipulated with a PC application software.

A wealth of functions and connection interfaces

AQ6370 Series

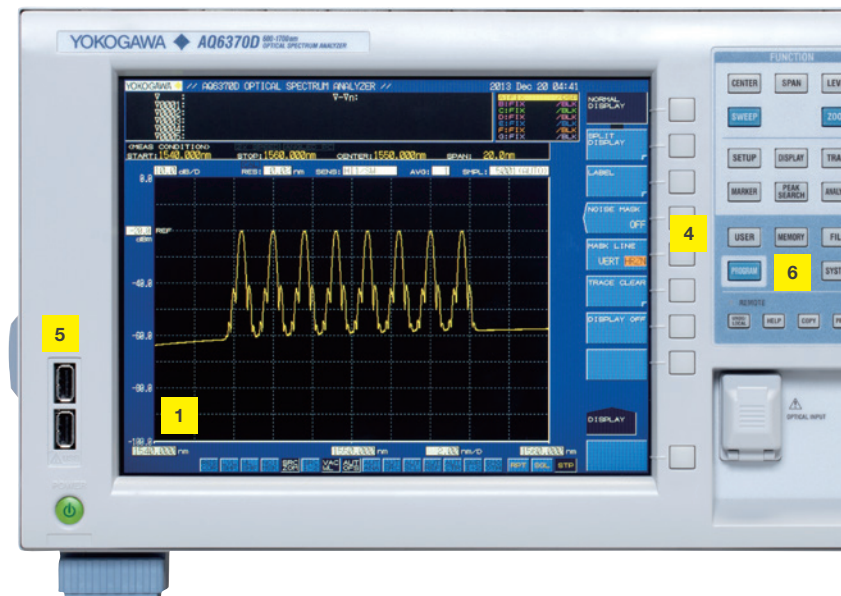

1

High Resolution Display

A large 10.4" SVGA LCD clearly displays detailed waveforms and numerical results. On-screen buttons facilitate the instrument setting by using the mouse.

2

Optical interfaces

The AQ6370D and AQ6375B offer a universal type optical connector system for optical input and calibration output enabling direct coupling to popular styles of optical connectors. The connectors can be replaced by users.

3

Rotary knob

This multifunctional knob allows easy and quick adjustment of parameters and settings.

4

USER button

Registering frequently used soft keys in the USER button allows execution of frequently used functions in a just a few steps.

5

USB

USB ports to easily operate on the instrument using a mouse and a keyboard.

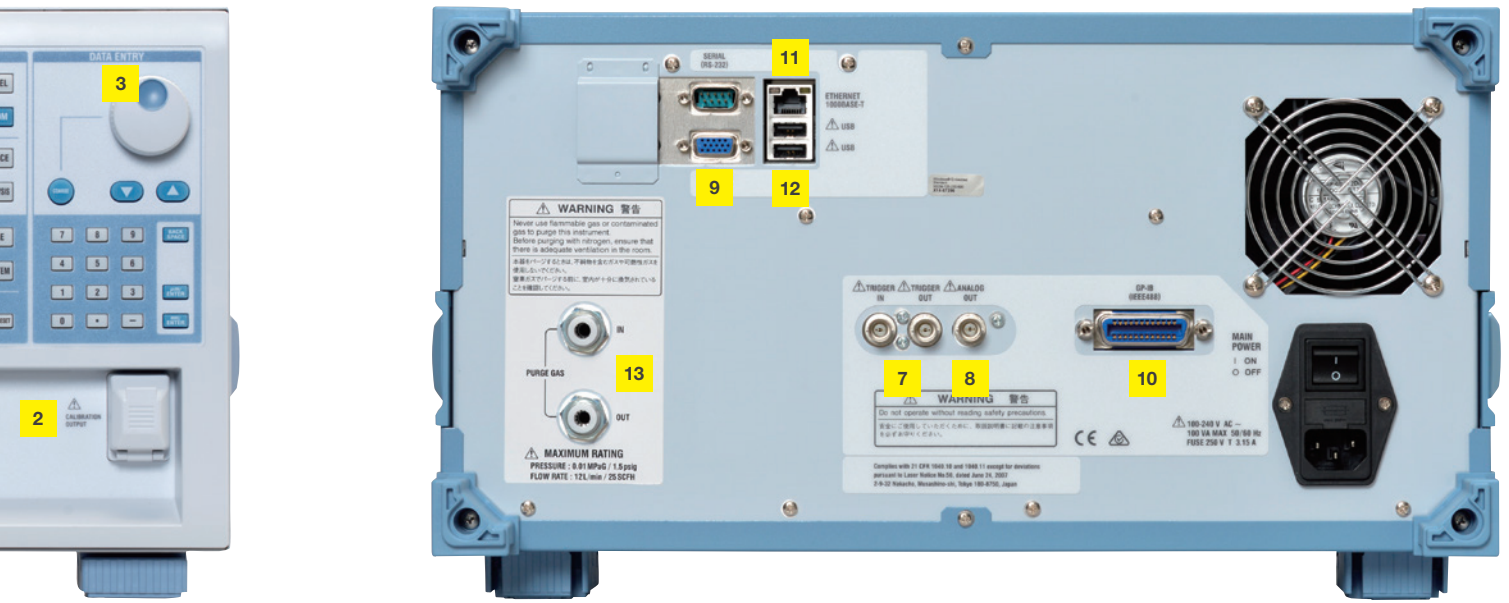

6
Macro programming button

User can compile up to 64 programs (200 steps per program) to build-up automatic measurement systems.

- No external PC is required.
- Easy to create test program by recording the user's actual key strokes and parameter selections.
- Can control external equipment through the remote interfaces.

7
Trigger IN/Trigger OUT
Pulsed light measurement, Gate sampling

8
Analog OUT
Voltage output for a stability test w/oscilloscope

9
Serial (RS-232)
Video OUT (SVGA)
Auxiliary interfaces

10
GP-IB
(IEEE 488.1/488.2)

11
Ethernet

12
USB (2X)

13
Purge gas IN/OUT
(AQ6375B only)

The OSA market leader in the telecom Industry

AQ6370D

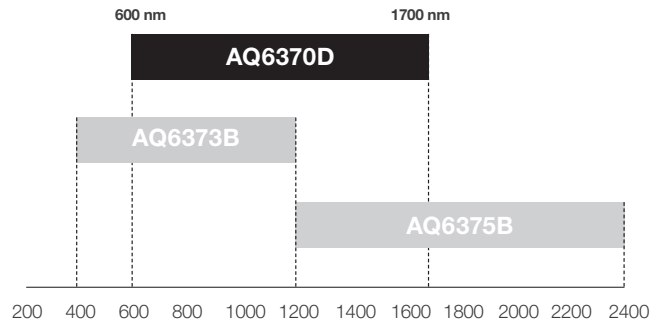

Its flexibility in parameters' setting and its unmatched performance make the AQ6370D model the best choice for R&D and Production of optical communication devices.

Discovering the characteristics of the AQ6370D

Wavelength range: 600 to 1700 nm

With its broad wavelength range coverage, AQ6370D is suitable to test devices designed for single-mode as well as multimode transmissions.

1 Standard- and high-performance models

There are two models available, with the high performance model providing even higher wavelength accuracy and dynamic range.

7 wavelength resolution settings: from 20 pm to 2 nm

To enable the user to choose the best value according to the characteristics of the DUT.

7 level sensitivity settings: down to -90 dBm

To enable the user to choose the best value according to test applications and measurement speed requirements.

High close-in dynamic range: 78 dB typ.

With sharp spectral characteristics of the AQ6370D monochromator, signals in close proximity can be clearly separated and accurately measured.

Fast measurement: only 0.2 sec for 100 nm span

With sensitivity set to NORM_AUTO (-70 dBm). Double speed mode increases the sweep speed up to 2 times compared to the standard sweep mode, with only a 2 dB penalty on the standard sensitivity value.

High wavelength accuracy: ± 0.01 nm

Easily maintained thanks to the built-in Calibration function and wavelength reference source (optional).

Wavelength range	Standard (-10)	High performance (-20)
1520-1580 nm	± 0.02 nm	± 0.01 nm
1580-1620 nm	± 0.02 nm	± 0.02 nm
1450-1520 nm	± 0.04 nm	± 0.04 nm
Full wavelength range	± 0.1 nm	± 0.1 nm

NOTE: AQ6370D model guarantees the high wavelength accuracy of ± 0.1 nm over the whole wavelength range from 600 nm to 1700 nm. In this manner Yokogawa supports customers with applications outside the C and L bands with highly reliable measurements.

13

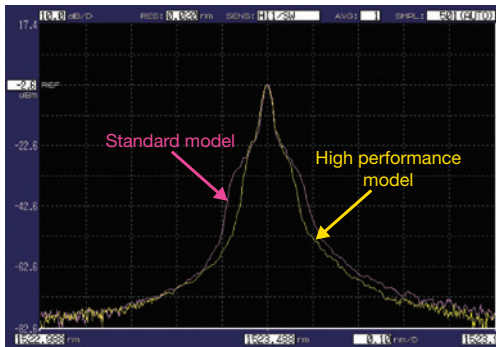

1

Example of the spectral shape

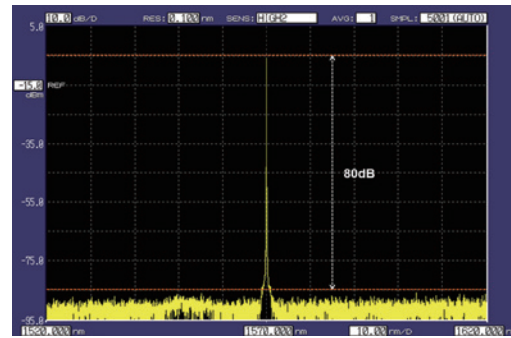

2

Straylight suppression ratio
(high dynamic mode: =off, high performance model)

2 High straylight suppression ratio: 80 dB typ.

The AQ6370D monochromator is specifically designed to offer excellent stray-light suppression capability without using the High Dynamic Mode setting which could increase the measurement time substantially when activated. Moreover, the AQ6370D is the first and only OSA in the world to guarantee the straylight suppression ratio specification.

Littrow light cancellation

The Littrow light is an artifact caused by a strong signal peak and appears at a wavelength about 200 nm below the actual signal peak. The advanced monochromator used in AQ6370D reduces the Littrow light appearance.

APC connector Level Correction function

Corrects the level offset caused by the higher insertion loss of Angled PC connectors.

12 Built-in Analysis Functions for popular applications

- WDM (OSNR) analysis
- Optical Fiber Amplifier analysis
- DFB-LD analysis
- FP-LD (VCSEL) analysis
- LED analysis
- Spectral Width analysis
- Notch Width analysis
- SMSR analysis
- PMD analysis
- Optical Power analysis
- Optical Filter analysis (PK, BTM, WDM-PK, WDM-BTM)
- Go/No-Go Judgment

Data Logging function

Records analysis results such as WDM analysis (OSNR, optical signal/noise ratio), distributed feedback laser diode (DFB-LD) analysis, and multi-peak measurements at up to 10,000 points per channel with time stamps. Recorded data can be displayed in table and graphical forms. This function is useful for the long-term stability testing and temperature cycle testing of systems and devices. The optical spectrum of each measurement can also be stored for reviewing and troubleshooting.

Advanced Marker function

Adds markers to obtain the power spectral density and the integrated power of a designated spectrum. This new feature makes it easy to get an OSNR value of the signal, whether modulated or not, directly from its spectrum.

Gate Sampling function

Facilitates the recirculating loop testing of optical transmission systems. Using an external gate signal, the AQ6370D obtains the optical spectrum of the signal which is passing through a certain loop.

Resolution Calibration function

Calibrates the resolution bandwidth with an external light source. With this new feature, the measurements of power spectral density of a broad spectrum light source will be more accurate.

Typical applications

AQ6370D

WDM OSNR test

AQ6370D's wide close-in dynamic range allows accurate OSNR measurement of DWDM transmission systems. The built-in WDM analysis function analyzes the measured waveform and shows peak wavelength, peak level and OSNR of WDM signals up to 1024 channels simultaneously. The Curve Fit function is used to accurately measure noise levels.

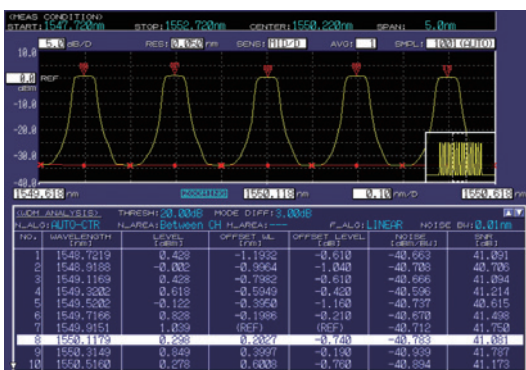
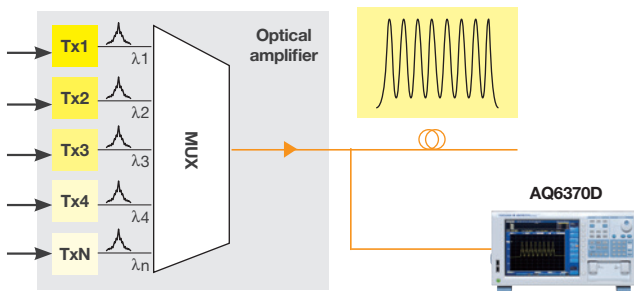

Example of WDM OSNR analysis

Optical amplifier test

The AQ6370D has an automated function for amplifier analysis under the name "EDFA-NF". Despite the name, it is in fact suitable for characterizing many types of optical amplifiers.

A typical measurement setup for amplifier testing is shown in figure 1. It consists of a set of multiplexed lasers, an attenuator for tuning the laser power level, an optical spectrum analyzer and of course the optical fiber amplifier. The set of lasers and the attenuator can be provided by Yokogawa Multi Application Test System (MATS¹), which is a modular instrument that allows different configurations for each specific test setup.

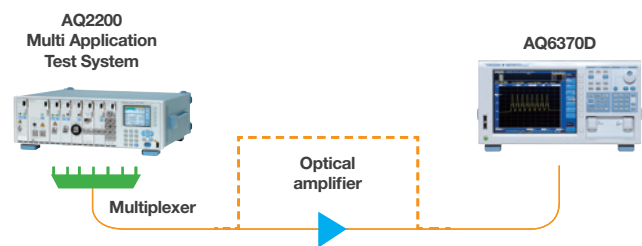

Figure 1 – The typical experimental setup for optical amplifier testing.

¹ See the Yokogawa AQ2200-Series at page 21

15

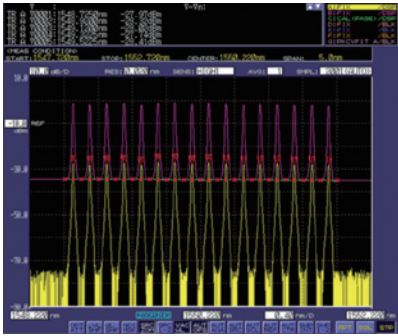

Figure 2 –Typical measurement result showing two traces; one before amplification (yellow) and one after amplification (purple).

The OSA takes two high-resolution recordings of the wavelength range that is covered by the lasers. One trace is taken before amplification and one after amplification. The obtained result will be close to the results shown in figure 2. Immediately it will be noticed that the recorded peaks after amplification will be higher than before amplification. The same holds for the noise levels.

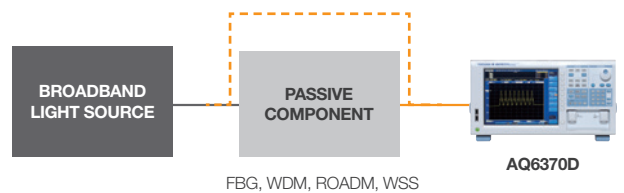

Figure 3 – The automated routine for the analysis of optical amplifiers provides a table with their relevant parameters

The EDFA-NF Analysis Function automatically detects the laser peaks, extracts the required measurement values, performs the calculations and displays in a table (figure 3) the values of ASE, GAIN and NF of the DUT.

Passive component test

In conjunction with a broadband light source such as ASE, SLD, SC light source, the OSA can simply perform evaluation of passive devices such as WDM filters and FBG. The AQ6370D's superb optical characteristics enable higher resolution and wider dynamic range measurements. The built-in optical filter analysis function simultaneously reports peak/bottom wavelength, level, crosstalk, and ripple width.



Optical transceiver test

In conjunction with bit error rate test (BERT) equipment, the AQ6370D can measure the center wavelength and spectral width of transceivers and LD modules. Various built-in analysis functions, such as DFB-LD, FP-LD (VCSEL), and LED facilitate the test process.



The OSA for emerging applications in VIS + NIR regions

AQ6373B

With the ability to provide high speed, accurate analysis of the wavelength range between 350 nm and 1200 nm, The AQ6373B is well suited for a broad range of applications. The AQ6373B can accelerate the development and manufacturing of short wavelength lasers, passive devices and LEDs as well as equipment that uses these devices for biomedical, material processing, consumer products and telecommunication applications. With built-in color analysis capabilities and remote command compatibility with the AQ6315, the AQ6373B provides an upgrade of features, speed and optical performance for the old AQ6315 users.

Discovering the characteristics of the AQ6373B

Wavelength Range: 350 to 1200 nm

10 wavelength resolution settings: from 10 pm to 10 nm

To enable the user to choose the best value according to the device/system under test.

7 level sensitivity settings: down to -80 dBm

To enable the user to choose the best value according to test applications and measurement speed requirements.

Wide measurable level range: from -80 dBm to +20 dBm

To be suitable to measure high power as well as low power sources used in different fields of application.

Wavelength accuracy: ± 0.05 nm

The wavelength accuracy can be maintained by the calibration using an external light source including HeNe laser and Argon light source.

Close-in dynamic range: 60 dB

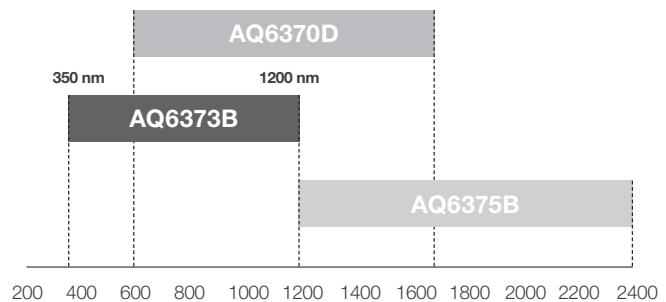

Fast measurement: only 0.5 sec for 100 nm span

with sensitivity set to NORM_AUTO (-70 dBm).

Double speed mode increases the sweep speed up to 2 times compared to the standard sweep mode, with only a 2 dB penalty to the standard sensitivity value.

Special optical free space input

suitable also for LARGE-CORE fibers, up to 800 μm .

Data Logging function

Records analysis results such as distributed feedback laser diode (DFB-LD) analysis and multi-peak measurements at up to 10,000 points per channel with time stamps.

Advanced Marker function

Adds markers to obtain the power spectral density and the integrated power of a designated spectrum.

Smoothing function

Reduces the noise on the measured spectrum

Color Analysis function

Enables the AQ6373B to show the chromatic coordinates of the light source under test.

12 built-in analysis functions for popular applications

- Spectral Width analysis
- DFB-LD analysis
- FP-LD analysis
- LED analysis
- Color Analysis
- Notch Width analysis
- SMSR analysis
- PMD analysis
- Optical Power analysis
- Optical filter analyses (PK, BTM)
- OSNR analysis
- Go/No-Go Judgment

17 Typical applications

AQ6373B

1 Visible LED test

The optical spectrum of visible LEDs used in lighting, signage, sensing and other applications can be measured and analyzed. By supporting the large core fiber input, AQ6373B can efficiently get the LED light and measure its spectrum. The built-in Color Analysis function automatically evaluates the dominant wavelength and the chromatic coordinates of the source.

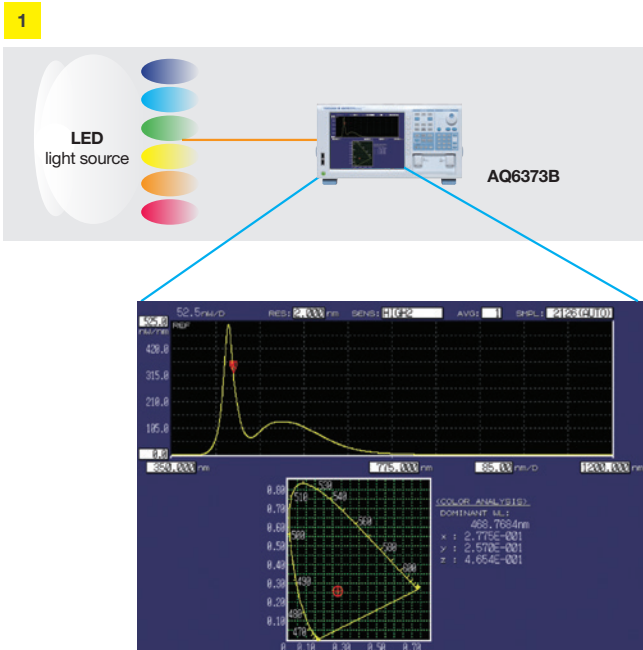

2 Analysis of FP-LD (VCSEL) sources

Today FP-LD sources emitting in the visible (VIS) wavelength range are mounted into many different devices/systems used in different areas of application, such as:

- **Industrial:** Barcode scanners, LiDAR surface scanners;
- **Consumer electronics:** audio output of Hi-Fi audio systems, laser printers, computer mice;
- **Automotive/home networking:** with Plastic Optical Fibers cabling.

405 nm FP-LD measurement (resolution setting: 0.01 nm)

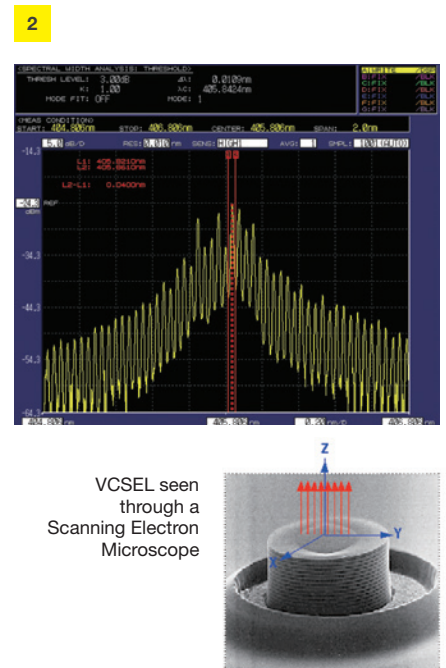

VCSEL seen through a Scanning Electron Microscope

The OSA for emerging applications in exNIR + SWIR regions

AQ6375B

The AQ6375B is the bench-top optical spectrum analyzer covering the long wavelengths over 2 μm . It is designed for researchers and engineers who have been struggling with inadequate test equipment to measure in these long wavelength ranges. The AQ6375B achieves high speed measurements with high accuracy, resolution and sensitivity, even while providing full analysis features. Troublesome calibration steps and the development of external analysis software is no longer required.

Discovering the characteristics of the AQ6375B

The features of AQ6375B are indispensable to the research, development and manufacturing of optical devices in the wavelength range from telecom band to 2.4 μm . No other test system can achieve this high performance and ease of use at the same time.

Wavelength range: 1200 to 2400 nm

The AQ6375B covers not only telecommunication wavelengths, but also the SWIR region which is often used for environmental sensing and medical applications.

6 wavelength resolution settings: from 50 pm to 2 nm

To enable the user to choose the best value according to the device/system under test.

Wide measurable level range: from -70 dBm to +20 dBm

To be suitable to measure high power as well as low power sources used in different fields of application

Wavelength accuracy: ± 0.05 nm

Easily maintained thanks to the built-in Calibration Function and wavelength reference source.

Close-in dynamic range: 55 dB

Fast measurement: only 0.5 sec for 100 nm span

with sensitivity set to NORM_AUTO (-60 dBm).

Double speed mode increases the sweep speed up to 2 times compared to the standard sweep mode, with only a 2 dB penalty to the standard sensitivity value.

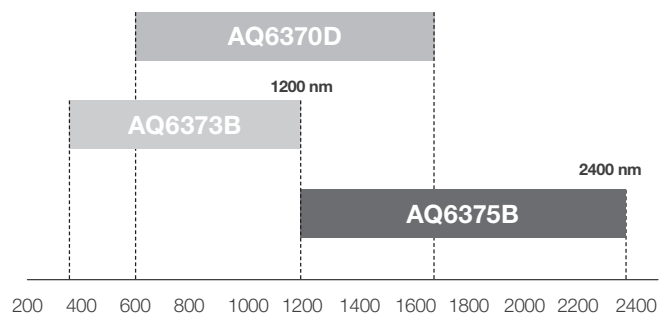

Horizontal scale also in Wave Number (cm^{-1})

in addition to the commonly-used scales in wavelength (nm) and frequency (THz).

12 built-in analysis functions for popular applications

DFB-LD analysis, SMSR analysis, Optical filter analysis, etc.

Data Logging function

Records analysis results such as distributed feedback laser diode (DFB-LD) analysis and multi-peak measurements at up to 10,000 points per channel with time stamps.

Smoothing function

Reduces the noise on the measured spectrum.

Purge feature

Due to the high resolution and sensitivity of the AQ6375B, it can actually detect the presence of water molecules in the air. The water vapor is detected in the upper Near-IR wavelength region and could overlap with or mask the spectral characteristics of the actual device under test in that particular region.

By continuously supplying a pure purge gas such as nitrogen to the monochromator through the ports on the back panel, the AQ6375B can reduce the influence of water vapor absorptions and provide more reliable and accurate measurements than ever before.

Built-in cut filter for high order diffracted light

Due to the diffractive technology used, the monochromator in some circumstances could generate high order diffracted light which appears at wavelengths equal to the integral multiple of input wavelengths.

By cutting incoming light below 1150 nm with the built-in filter, the AQ6375B drastically reduces the influence of high order diffracted light on the measurement. Thus, the measured data are always reliable and replicate the real signal under test.

19 Typical applications

AQ6375B

Characterization of sources used in laser Absorption Spectroscopy

Laser Absorption Spectroscopy is a measurement technique used to detect and measure the gases concentration in the air, in open or closed environment. The lasers used in Absorption Spectroscopy require excellent single-mode operation performance, which directly determines the limits of detection. Furthermore such lasers should produce a stable oscillation in the absorption region in order to achieve sensitive detection of the gas of interest. Most of the greenhouse gases, for example CO₂, SO₂, NO_x and CH₄, have strong absorption lines in the 2 μm wavelength region.

The lasers used in Absorption Spectroscopy are DFB-LD and VCSEL. Important parameters for evaluating the performance of these lasers are the Side Mode Suppression Ratio (which is the amplitude difference between the main mode and the side mode), and the Spontaneous Emission level (which is the magnitude of background noise light). Both parameters can be accurately and quickly measured by the AQ6375B.

Figure 1 shows the result of measurement of the spectrum of a DFB-LD that oscillates in the near-infrared region of 2 μm with the single vertical mode.

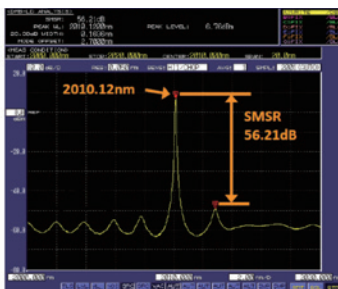

Figure 1 – Measurement example of 2010 nm DFB-LD with AQ6375B (Res: 0.05 nm, Span: 20 nm)

Characterization of Supercontinuum light sources

Supercontinuum light is generated by promoting highly nonlinear optical processes in special materials, e.g. photonic crystal fiber, by pumping them with a mode-locked pulsed laser (typically a femtosecond Ti:Sapphire laser). Supercontinuum light can be best described as ‘broad as a lamp, bright as a laser’, in fact it matches the characteristics of incandescent and fluorescent lamps - i.e. very broad spectrum - with the characteristics of lasers - i.e. high spatial coherence and very high brightness, which enables optimum coupling to a fibre and outstanding single-mode beam quality.

The Supercontinuum light sources are nowadays finding applications in a diverse range of fields, including optical coherence tomography, frequency metrology, fluorescence lifetime imaging, optical communications, gas sensing and many others.

The AQ6375B, thanks to its premium performance, is the right instrument to tests and characterize Supercontinuum light sources during their production and after-production quality check processes.

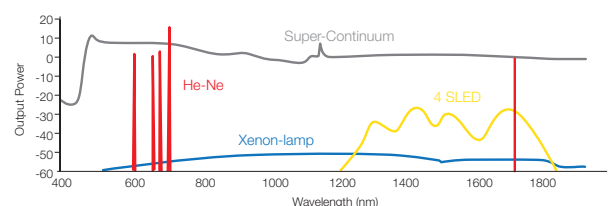

source: <http://www.nktpotonics.com/supercontinuum>

Characterization of Fiber Bragg Gratings

A Fiber Bragg Grating (FBG) is a type of distributed Bragg reflector constructed in a short segment of optical fiber that reflects particular wavelengths of light and transmits all the others. This is achieved by creating a periodic variation in the refractive index of the fiber core, which generates a wavelength specific dielectric mirror. A Fiber Bragg Grating can therefore be used as an inline optical filter to block certain wavelengths, or as a wavelength-specific reflector (Figure 2). The primary application of Fiber Bragg Gratings is in optical communications systems: they are specifically used as notch filters and they are also used in optical multiplexers and demultiplexers with an optical circulator, or optical add-drop multiplexer (OADM). Fiber Bragg Gratings tuned on 2-3 μm region are used also as direct sensing elements for strain and temperature in instrumentation applications such as seismology and in pressure sensors for extremely harsh environments. To characterize FBGs, the AQ6375B's high wavelength resolution and high dynamic range are indispensable.

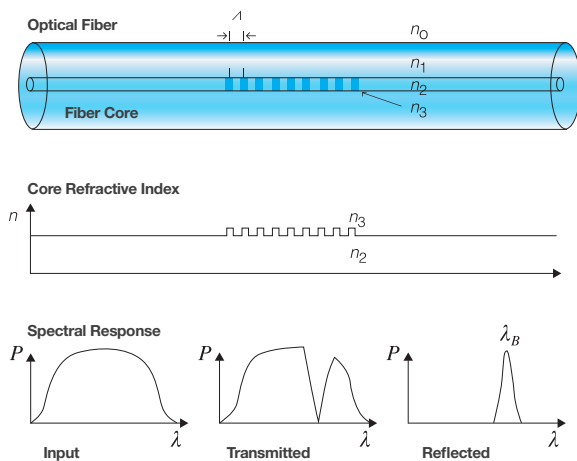

Figure 2

Gas detection and concentration measurements

Used together with a broadband light source like Super Continuum (SC) or Super Luminescent Diode (SLD), the AQ6375B can show the absorption spectrum of the gas mixture under test, like figure 3.

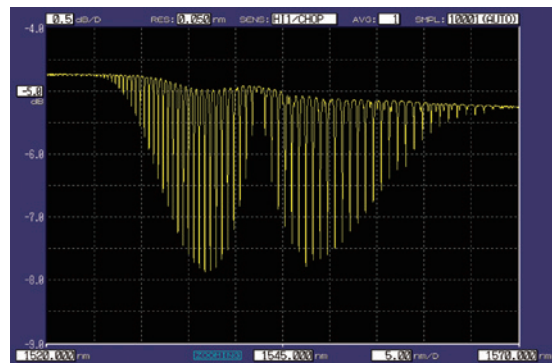

Figure 3 – Hydrogen Cyanide $\text{H}_{13}\text{C}_{14}\text{N}$ absorption spectrum measurement

The global warming gases, called greenhouse gases, like CO_2 , SO_2 , NO_x and CH_4 , has strong absorption lines in the 2 μm wavelength region. The presence and concentration of those gases in the atmosphere can be determined by measuring the optical absorption spectrum of the gas mixture under test.

Thanks to its free space optical input, the AQ6375B can also measure the absorption spectrum of an air column using the Sun as light source and transferring by a multi-mode fiber the light passed-through the mixture. Figure 4.

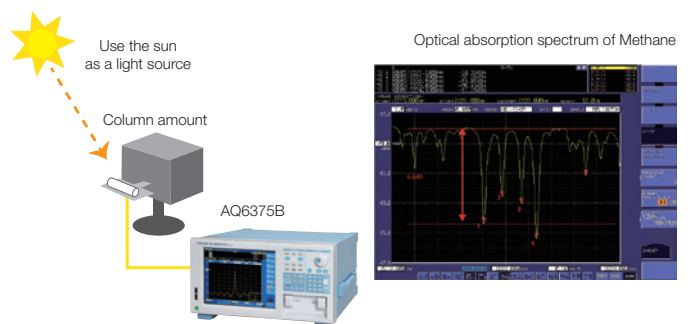

Figure 4 – Measurement setup to detect a specific gas in the air, e.g. Methane (CH_4)

21

Accessories and related products

AQ6370 Series accessories and related products are available to fully support your testing needs.

NA Conversion Adapter

The Numerical Aperture (NA) Conversion Adapter is a unique adapter that reduces to half the NA of a connected fiber and is only applicable to the AQ6370 series in which free space optical input structure is used. With this adapter, the AQ6370 series improves the dynamic range (signal to noise ratio) in the passive component measurement and the level stability in the active device measurement.



Adapter Code	Applicable fiber	Wavelength range
735383-A001	Multimode fiber GI 50/125 μm	350 to 1700 nm
735383-A002	Multimode fiber GI 62.5/125 μm	350 to 1700 nm

AQ2200 Series Multi-Application Test System (MATS)

The AQ2200 MATS is the ideal system for measuring and evaluating a wide range of optical devices and optical transmission systems.

A variety of measurement modules are available, including: high-stability light sources, high-speed optical sensors, high-resolution variable optical attenuators, low insertion loss optical switches and optical transceiver interfaces. These modules can be installed in any combination on a single platform, providing an ideal measurement system for a variety of applications.

The AQ2200 Multi Application Test System is available in two different frame controller platforms. Each model has a certain number of slots for housing modules, so you can select the best platform size for your measurement application.



AQ6150 Series Optical Wavelength Meters

The AQ6150 and AQ6151 Optical Wavelength Meters are fast, accurate and cost-effective instruments for carrying out measurements in the telecommunications wavelength range from 1270 to 1650 nm. Their high wavelength accuracy and measurement speed make them particularly suited to the production testing of active optical devices such as tunable lasers.



AQ6370D

Items		Specifications	
Spec-code		Standard (-10)	High performance (-20)
Wavelength range ^{*1}		600 to 1700 nm	
Span ^{*1}		0.1 nm to 1100 nm (full span), and 0 nm	
Wavelength accuracy ^{*1, *2, *5}		±0.02 nm (1520 to 1580 nm) ±0.02 nm (1580 to 1620 nm) ±0.04 nm (1450 to 1520 nm) ±0.10 nm (Full range)	±0.01 nm (1520 to 1580 nm) ±0.02 nm (1580 to 1620 nm) ±0.04 nm (1450 to 1520 nm) ±0.10 nm (Full range)
Wavelength linearity ^{*1, *2, *5}		±0.01 nm (1520 to 1580 nm), ±0.02 nm (1450 to 1520 nm, 1580 to 1620 nm)	
Wavelength repeatability ^{*1, *2}		±0.005 nm (1 min.)	
Wavelength resolution setting ^{*1, *2}		0.02, 0.05, 0.1, 0.2, 0.5, 1 and 2 nm	
Wavelength resolution bandwidth accuracy ^{*1, *2}		±5% (1450 to 1620 nm, Resolution setting: ≥ 0.1 nm, after performing the Resolution Calibration function, at the wavelength of resolution calibration)	
Min. sampling resolution ^{*1}		0.001 nm	
Number of sampling		101 to 50001, AUTO	
Level sensitivity setting		NORM_HOLD, NORM_AUTO, NORMAL, MID, HIGH1, HIGH2 and HIGH3	
High dynamic mode		SWITCH (Sensitivity: MID, HIGH1-3)	
Level sensitivity ^{*2, *3, *4, *7}		-90 dBm (1300 to 1620 nm), -85 dBm (1000 to 1300 nm), -60 dBm (600 to 1000 nm) (Sensitivity: HIGH3)	
Maximum input power ^{*2, *3}		+20 dBm (Per channel, full range)	
Maximum safe input power ^{*2, *3}		+25 dBm (Total input power)	
Level accuracy ^{*2, *3, *4, *6}		±0.4 dB (1310/1550 nm, Input level: -20 dBm, Sensitivity: MID, HIGH1-3)	
Level linearity ^{*2, *3}		±0.05 dB (Input level: -50 to +10 dBm, Sensitivity: HIGH1-3)	
Level flatness ^{*2, *3, *6}		±0.1 dB (1520 to 1580 nm), ±0.2 dB (1450 to 1520 nm, 1580 to 1620 nm)	
Polarization dependence ^{*2, *3, *6}		±0.05 dB (1550/1600 nm), ±0.08 dB (1310 nm)	
Dynamic range ^{*1, *2, *8}	Resolution: 0.02 nm	55 dB (Peak ±0.2 nm) 37 dB (Peak ±0.1 nm)	58 dB (Peak ±0.2 nm, Typ. 60 dB) 45 dB (Peak ±0.1 nm, Typ. 50 dB)
	Resolution: 0.05 nm	73 dB (Peak ±1.0 nm) 62 dB (Peak ±0.4 nm) 45 dB (Peak ±0.2 nm)	73 dB (Peak ±1.0 nm, Typ. 78 dB) 64 dB (Peak ±0.4 nm, Typ. 70 dB) 50 dB (Peak ±0.2 nm, Typ. 55 dB)
	Resolution: 0.1 nm	57 dB (Peak ±0.4 nm) 40 dB (Peak ±0.2 nm)	60 dB (Peak ±0.4 nm, Typ. 67 dB) 45 dB (Peak ±0.2 nm, Typ. 50 dB)
Stray-light suppression ratio ^{*7, *10}		73 dB	76 dB (Typ. 80 dB)
Optical return loss ^{*11}		Typ. 35 dB (with angled-PC connector)	
Applicable fiber		SM (9.5/125 μm), GI (50/125 μm, 62.5/125 μm)	
Optical connector		Optical input : AQ9447 (□□) Connector adapter (option) required. Calibration output: AQ9441 (□□) Universal adapter (option) required. (□□) Connector type FC or SC	
Built-in calibration light source ^{*12}		Wavelength reference source (For optical alignment and wavelength calibration)	
Sweep time ^{*1, *7, *9}		NORM_AUTO: 0.2 sec, NORMAL: 1 sec, MID: 2 sec, HIGH1: 5 sec, HIGH2: 20 sec, HIGH3: 75 sec	
Warm-up time		Minimum 1 hour (After warming up, optical alignment adjustments required.)	

*1: Horizontal scale: Wavelength display mode.

*2: With 9.5/125 μm single mode fiber with a PC type connector, after 1 hour of warm-up, after optical alignment with built-in reference light source or a single longitudinal mode laser (wavelength 1520 - 1560 nm, peak level ≥ -20 dBm, level stability ≤ 0.1 dBpp, and wavelength stability ≤ ±0.01 nm).

*3: Vertical scale: Absolute power display mode, Resolution setting: ≥ 0.05 nm, Resolution correction: OFF.

*4: With 9.5/125 μm single mode fiber (B1.1 type defined on IEC60793-2, PC polished, mode field diameter: 9.5 μm, NA: 0.104 to 0.107).

*5: After wavelength calibration with built-in reference light source or a single longitudinal mode laser (wavelength 1520 - 1560 nm, peak level ≥ -20 dBm and absolute wavelength accuracy ±0.003 nm).

*6: Temperature condition changes to 23 ±3°C at 0.05 nm resolution setting.

*7: High dynamic mode: OFF, Pulse light measurement mode: OFF, Resolution correction: OFF.

*8: 1523 nm, High dynamic mode: SWITCH, Resolution correction: OFF

*9: Span: ≤ 100 nm, Number of sampling: 1001, Average number: 1.

*10: With He-Ne laser (1523 nm), 0.1 nm resolution setting, 1520 nm to 1620 nm except for peak wavelength ±2 nm.

*11: With Yokogawa's master single mode fiber with an angled-PC connector. Typ. 15 dB with PC connector.

*12: Option.

"Typical" or "typ." in this document means "Typical value", which is for reference, not guaranteed specification.

Functions

Items		Functions
Measurement	Measurement mode	CW light, Pulsed light, External trigger, Gate sampling, Air/vacuum wavelength
	Sweep mode	Repeat, Single, AUTO (Self-configuration), Sweep between line markers, Zero span sweep (0 nm span), Data logging
	Condition settings	Center wavelength, Span, Number of sampling, Wavelength resolution, Sensitivity, High dynamic mode, Number of averaging (1 to 999 times), Double speed mode, Smoothing, APC level correction ^{*1} , Large core size fiber mode (A6373B only)
	Others	Sweep status output, Analog output
Display	Vertical scale	Level scale (0.1 to 10 dB/div. and linear), Level subscale (0.1 to 10 dB/div. and linear), Reference level, Divisions (8, 10 or 12), power spectral density (dB/nm), dB/km, %, Noise mask
	Horizontal scale	Wavelength (nm), Frequency (THz), Wave number (cm ⁻¹) (AQ6375B only), Trace zoom in/out
	Display mode & items	Normal display, Split display, Data table, Label, Template, Measurement conditions
Trace	Trace functions	7 independent traces, Maximum/Minimum hold, Calculation between traces, Normalizing, Curve fit, Peak curve fit, Marker curve fit, Roll averaging (2 to 100 times)
	Others	Trace copy/clear, Write/Fix setting, Display/Blank setting
Marker & Search	Marker	Delta markers (Max. 1024), Vertical/horizontal line markers, Advanced markers
	Search	Peak, Bottom, Next peak, Next bottom, Multi peak, Multi bottom, Auto-search (On/OFF), Search between horizontal line markers, Search zoomed area
Data analysis	Analysis functions	Spectral width (threshold, envelope, RMS, peak-RMS, notch), WDM (OSNR) analysis, EDFA-NF analysis (excl. AQ6373B), Filter peak/bottom analysis, WDM filter peak/bottom analysis (excl. AQ6373B), DFB-LD/ FP-LD/ LED analysis, SMSR analysis, Power analysis, PMD analysis, Color analysis (AQ6373B only), Pass/Fail analysis with template
	Others	Auto-analysis (ON/OFF), Analysis between horizontal line markers, Analysis in zoomed area
Automated measurement	Program function	64 programs, 200 steps per program
Other functions	Optical alignment	Auto-optical alignment with built-in light source or an external reference source.
	Wavelength calibration	Auto-wavelength calibration with built-in wavelength reference source (excl. AQ6373B) or an external wavelength reference source. Note. AQ6373B requires an external reference source for wavelength calibration.
	Resolution calibration ^{*1}	Resolution calibration with an external reference source.

*1: AQ6370D only

AQ6373B

Items	Specifications
Wavelength range ^{*1}	350 to 1200 nm
Span ^{*1}	0.5 nm to 850 nm (full span), and 0 nm
Wavelength accuracy ^{*1}	±0.05 nm (633 nm), ±0.20 nm (400 to 1100 nm) (After wavelength calibration with 633 nm He-Ne laser.)
Wavelength resolution setting ^{*1, *2}	0.02, 0.05, 0.1, 0.2, 0.5, 1, 2, 5, 10 nm (full range), and 0.01 nm (400 to 470 nm)
Minimum sampling resolution ^{*1}	0.001 nm
Number of sampling	101 to 50001, AUTO
Level sensitivity setting	NORM_HOLD, NORM_AUTO, NORMAL, MID, HIGH1, HIGH2 and HIGH3
High dynamic mode	SWITCH (Sensitivity: MID, HIGH1-3)
Level sensitivity ^{*3}	-80 dBm (500 to 1000 nm), -60 dBm (400 to 500 nm, 1000 to 1100 nm) (Typical, Resolution setting: ≥ 0.2 nm, Averaging: 10 times, Sensitivity: HIGH3)
Maximum safe input power ^{*3}	+20 dBm (550 to 1100 nm), +10 dBm (400 to 550 nm) (Total input power)
Level accuracy ^{*2}	±1.0 dB (850 nm, Input level: -20 dBm, Resolution setting: ≥ 0.2 nm, Sensitivity: MID, HIGH1-3, SMF [MFD 5 μm@850 nm, NAO.14])
Level linearity ^{*3}	±0.2 dB (Input level: -40 to 0 dBm, Sensitivity: HIGH1-3)
Dynamic range ^{*1}	60 dB (Peak ±0.5 nm, Resolution setting: 0.02 nm, 633 nm, Sensitivity: HIGH1-3)
Applicable fiber	SM, GI (50/125 μm, 62.5/125 μm), Large core fiber (up to 800 μm)
Optical connector	FC type (Optical input and Calibration output)
Built-in calibration light source	Optical alignment source (for optical alignment. Wavelength reference is not equipped.)
Sweep time ^{*1, *4}	NORM_AUTO: 0.5 sec, NORMAL: 1 sec, MID: 2 sec, HIGH1: 5 sec, HIGH2: 20 sec, HIGH3: 75 sec
Warm-up time	Minimum 1 hour (After warming up, optical alignment adjustment with built-in light source is required.)

Performance and functions can be limited by type of used fiber. The specifications are only guaranteed when a single mode fiber in which light travels in single mode at measured wavelength is used. In case that measured wavelength is less than the cut-off wavelength of the used fiber, or a multimode fiber is used, a measured spectrum may be inaccurate due to a speckle noise. Please be cautious especially when measuring high coherency sources like gas laser and Laser diode.

- *1: Horizontal scale: Wavelength display mode.
- *2: Actual wavelength resolution varies according to a measured wavelength. Actual resolution at 10 nm resolution setting is about 8 nm at most.
- *3: Vertical scale: Absolute power display mode.
- *4: High dynamic mode: OFF, Number of sampling: 1001, Average number: 1, Span: ≤ 100 nm excluding 450 to 470 nm and 690 to 700 nm.

AQ6375B

Items	Specifications
Wavelength range ^{*1}	1200 to 2400 nm
Span ^{*1}	0.5 nm to 1200 nm (full span), and 0 nm
Wavelength accuracy ^{*1, *2, *3}	±0.05 nm (1520 to 1580 nm), ±0.10 nm (1580 to 1620 nm), ±0.50 nm (Full range)
Wavelength repeatability ^{*1, *2}	±0.015 nm (1 min.)
Wavelength resolution setting ^{*1, *2}	0.05, 0.1, 0.2, 0.5, 1 and 2 nm
Minimum sampling resolution ^{*1}	0.002 nm
Number of sampling	101 to 50001, AUTO
Level sensitivity setting	NORM_HOLD, NORM_AUTO, NORMAL, MID, HIGH1, HIGH2 and HIGH3 (Only High dynamic mode (/CHOP) in HIGH1-3)
Level sensitivity ^{*2, *3, *4, *8}	-70 dBm (1800 to 2200 nm), -67 dBm (1500 to 1800 nm, 2200 to 2400 nm), -62 dBm (1300 to 1500 nm) (Sensitivity: HIGH3)
Maximum input power ^{*2, *3}	+20 dBm (Per channel, full wavelength range)
Maximum safe input power ^{*2, *3}	+25 dBm (Total input power)
Level accuracy ^{*2, *3, *4, *8}	±1.0 dB (1550 nm, input level: -20 dBm, Sensitivity: MID, HIGH1-3)
Level linearity ^{*2, *3}	±0.05 dB (Input level: -30 to +10 dBm, Sensitivity: HIGH1-3)
Polarization dependence ^{*2, *3, *8}	±0.1 dB (1550 nm)
Dynamic range ^{*1, *2}	45 dB (Peak ±0.4 nm, resolution: 0.05 nm), 55 dB (Peak ±0.8 nm, resolution: 0.05 nm) (1523 nm, Sensitivity: HIGH1-3)
Applicable fiber	SM, GI (50/125 μm, 62.5/125 μm)
Optical connector	Optical input : AQ9447 (□□) Connector adapter (option) required. Calibration output: AQ9441 (□□) Universal adapter (option) required. (□□) Connector type FC or SC
Built-in calibration light source	Wavelength reference source (for optical alignment and wavelength calibration)
Sweep time ^{*1, *6, *7}	NORM_AUTO: 0.5 sec, NORMAL: 1 sec, MID: 10 sec, HIGH1: 20 sec
Warm-up time	Minimum 1 hour (After warming up, optical alignment adjustment with built-in light source is required.)

- *1: Horizontal scale: Wavelength display mode.
- *2: With 9.5/125 μm single mode fiber, after 2 hours of warm-up, after optical alignment with built-in reference light source, when the purge gas is not used.
- *3: Vertical scale: Absolute power display mode, Resolution setting: ≥ 0.1 nm.
- *4: With 9.5/125 μm single mode fiber (B1.1 type defined on IEC60793-2, PC polished, mode field diameter: 9.5 μm, NA: 0.104 to 0.107).
- *5: After wavelength calibration with built-in reference light source, Sampling resolution: ≤ 0.003 nm, Sensitivity: MID, HIGH1-3
- *6: Pulse light measurement mode: OFF.
- *7: Span: ≤ 100 nm, Number of sampling: 1001, Average number: 1.
- *8: Temperature condition changes to 23 ±3°C at 0.1 nm resolution setting.

General Specifications

Items	Specifications	
Electrical interface	GP-IB, RS-232, Ethernet, USB, SVGA output, Analog output port, Trigger input port, Trigger output port	
Remote control ^{*1}	GP-IB, RS-232, Ethernet (TCP/IP), AQ6317 series compatible commands (IEEE488.1) and IEEE488.2	
Purge gas input/output terminals ^{*3}	Outer diameter 1/4 inch, nylon tube	
Data storage	Internal storage: 512 MBytes, Internal memory: 64 Traces, 64 programs, 3 template lines, External storage: USB storage (memory/HDD), FAT32 format File types: CSV (text), Binary, BMP, TIFF	
Display ^{*2}	10.4-inch color LCD (Resolution: 800 x 600)	
Dimensions	426 (W) × 221 (H) × 459 (D) mm (Excluding protector and handle)	
Mass	AQ6370D/AQ6373B: 19 kg, AQ6375B: 23 kg	
Power requirements	100 to 240 V AC, 50/60 Hz, approx. 100 VA (AQ6370D/AQ6373B), 150 VA (AQ6375B)	
Environmental conditions	Performance guarantee temperature: +18 to +28°C, Operating temperature: +5 to +35°C Storage temperature: -10 to +50°C, Humidity: 20 to 80%RH (no condensation)	
Safety standards	EN61010-1	
EMC	Laser	IEC 60825-1 Class 1
	Emission	EN61326-1 Class A, EN55011 Class A Group 1
Immunity		EN61326-1 Table 2
	RoHS	EN50581
Recommended calibration period	1 year	

- *1: Some AQ6317 series commands may not be compatible due to changes in specifications or functions.
- *2: Liquid crystal display may include a few defective pixels (within 0.002% with respect to the total number of pixels including RGB). There may be a few pixels on the liquid crystal display that do not emit all the time or remains ON all the time. These are not malfunctions.
- *3: AQ6375B only
- *4: With built-in calibration light source

Dimensions

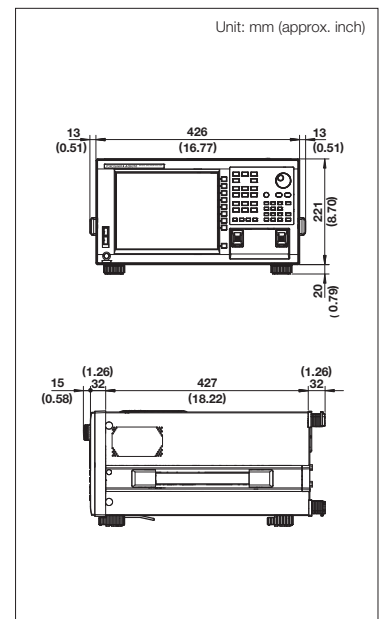

Ordering Information

Models and suffix codes

AQ6370D

Model	Suffix	Descriptions	
AQ6370D		AQ6370D Optical Spectrum Analyzer	
Spec code	-10	Standard model	
	-20	High performance model	
Built-in light source	-L0	Without light source	
	-L1	Wavelength reference source	
Power cord	-D	UL/CSA standard	
	-F	VDE standard	
	-R	AS standard	
	-H	GB standard	
	-Q	BS standard	
	-N	NBR standard	
	Factory installed options	/FC	AQ9447(FC) Connector Adapter
/SC		AQ9447(SC) Connector Adapter	
/RFC		AQ9441(FC) Universal Adapter	For Calibration Output
/RSC		AQ9441(SC) Universal Adapter	

AQ6373B

Model	Suffix	Descriptions	
AQ6373B		AQ6373B Optical Spectrum Analyzer	
Spec code	-10	Standard model	
Built-in light source	-L1	Optical alignment source	
Power cord	-D	UL/CSA standard	
	-F	VDE standard	
	-R	AS standard	
	-H	GB standard	
	-Q	BS standard	
	-N	NBR standard	

AQ6375B

Model	Suffix	Descriptions	
AQ6375B		AQ6375B Optical Spectrum Analyzer	
Spec code	-10	Standard model	
Built-in light source	-L1	Wavelength reference source	
Power cord	-D	UL/CSA standard	
	-F	VDE standard	
	-R	AS standard	
	-H	GB standard	
	-Q	BS standard	
	-N	NBR standard	
	Factory installed options	/FC	AQ9447(FC) Connector Adapter
/SC		AQ9447(SC) Connector Adapter	
/RFC		AQ9441(FC) Universal Adapter	For Calibration Output
/RSC		AQ9441(SC) Universal Adapter	

Factory Installed Options

Optical Connector Adapters (AQ6370D & AQ6375B)

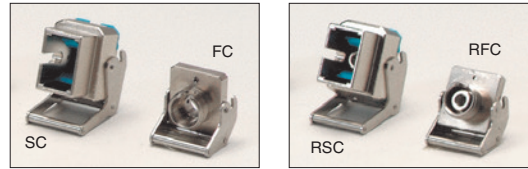

For optical input port
AQ9447 Connector Adapter
/SC, /FC

For calibration output port
AQ9441 Universal Adapter
/RSC, /RFC

Accessories (optional)

Model	Suffix	Descriptions
735371		AQ6370 Viewer (For all the AQ6370 series models)
810804602		AQ9447 Connector Adapter
	Connector type	-FCC FC type
		-SCC SC type
813917321		AQ9441 Universal Adapter
	Connector type	-FCC FC type
		-SCC SC type
735383		NA Conversion Adapter (for GI50/125 μm)
		-A002 NA Conversion Adapter (for GI62.5/125 μm)
751535	-E5	19 inch Rack mount kit

■ Microsoft, MS, and Windows are registered trademarks or trademarks of Microsoft Corporation in the US and other countries. LabVIEW is a U.S. registered trademark of National Instruments.
Other company names and product names appearing in this document are the registered trademarks of their respective companies.

NOTICE

- Before operating the product, read the user's manual thoroughly for proper and safe operation.

Yokogawa's Approach to Preserving the Global Environment

- Yokogawa's electrical products are developed and produced in facilities that have received ISO14001 approval.
- In order to protect the global environment, Yokogawa's electrical products are designed in accordance with Yokogawa's Environmentally Friendly Product Design Guidelines and Product Design Assessment Criteria.

YOKOGAWA

YMI-KS-MI-SE01

YOKOGAWA METERS & INSTRUMENTS CORPORATION

Global Sales Dept. /Phone: +81-422-52-6237 Facsimile: +81-422-52-6462
E-mail: tm@cs.jp.yokogawa.com

YOKOGAWA CORPORATION OF AMERICA
YOKOGAWA EUROPE B.V.
YOKOGAWA SHANGHAI TRADING CO., LTD.
YOKOGAWA ELECTRIC KOREA CO., LTD.
YOKOGAWA ENGINEERING ASIA PTE. LTD.
YOKOGAWA INDIA LTD.
YOKOGAWA ELECTRIC CIS LTD.
YOKOGAWA AMERICA DO SUL LTDA.
YOKOGAWA AUSTRALIA PTY. LTD.
YOKOGAWA MIDDLE EAST & AFRICA B.S.C(c)

Phone: +1-770-253-7000
Phone: +31-88-4641000
Phone: +86-21-6239-6363
Phone: +82-2-2628-3810
Phone: +65-6241-9933
Phone: +91-80-4158-6000
Phone: +7-495-737-7868
Phone: +55-11-5681-2400
Phone: +61-2-8870-1100
Phone: +973-17-358100

Facsimile: +1-770-254-0928
Facsimile: +31-88-4641111
Facsimile: +86-21-6880-4987
Facsimile: +82-2-2628-3899
Facsimile: +65-6241-2606
Facsimile: +91-80-2852-8656
Facsimile: +7-495-737-7869
Facsimile: +55-11-5681-4434
Facsimile: +61-2-8870-1111
Facsimile: +973-17-336100

Subject to Change without notice.
Copyright © 2014, Yokogawa Meters & Instruments Corporation
[Ed: 04/b]
Printed in Japan, 509(KP)

<http://tmi.yokogawa.com/>